

## Premium Preparation 2000 mm Hot Cupboard

ITEM # \_\_\_\_\_

MODEL # \_\_\_\_\_

NAME # \_\_\_\_\_

SIS # \_\_\_\_\_

AIA # \_\_\_\_\_

**133092 (TC2000EN)**

 Hot Cupboard, with 1 shelf  
and 2 sliding doors, (6 feet),  
2000mm

### Short Form Specification

**Item No.** \_\_\_\_\_

The 50mm high worktop in 304 AISI stainless steel, 1,5mm in thickness, is sound-deadened and has anti-drip edges and welded corners. Inner welded frame in stainless steel. Under-top reinforcement in 304 AISI s/s. Intermediate reinforced shelf in 304 AISI s/s that can be positioned at three different heights. Base shelf in 304 AISI s/s, 1mm in thickness, reinforced by 1,5mm support bars in AISI 304 s/s. Two sound-deadened sliding doors in 304 AISI s/s. Welded construction for maximum strength. Ventilated hot air flow system guarantees temperature evenness, air flows underneath the intermediate shelf and throughout the cabinet. Thermostat with digital display to adjust the internal temperature (up to 75°C). Six 2"-feet in 304 AISI stainless steel, h=200mm, adjustable in height (-50+20mm).

### Main Features

- Model specific to keep dishes warm.
- Ideal for central positioning in the kitchen.
- Handles in stainless steel for better hygiene and reliability.
- Digital display thermostat to control the internal temperature.
- Sturdiness, stability and reliability of table accurately tested.

### Construction

- Base panel has 40mm high profile, is 8/10 in thickness with upturned edges and bar reinforcement. It is welded to legs for further structure reinforcement.
- Inner welded frame in stainless steel to guarantee superior strength and stability.
- Base panel in AISI 304 stainless steel, 10/10 in thickness reinforced by 15/10 support bars in AISI 304.
- Intermediate shelf in stainless steel with riveted corners and trasversal reinforcement in stainless steel.
- 100 mm upstand with 10 mm radiused corner and 13 mm deep, designed to be used against a wall.
- Heavy duty construction entirely in AISI 304 stainless steel to offer maximum durability.
- 304 AISI stainless steel feet, 150 mm high and 54 mm in diameter, adjustable by -35/+25 mm.

### Optional Accessories

- Wheel kit for cupboards, 4 wheels (2 with brakes), D=1000 mm PNC 855299

**APPROVAL:** \_\_\_\_\_

Front

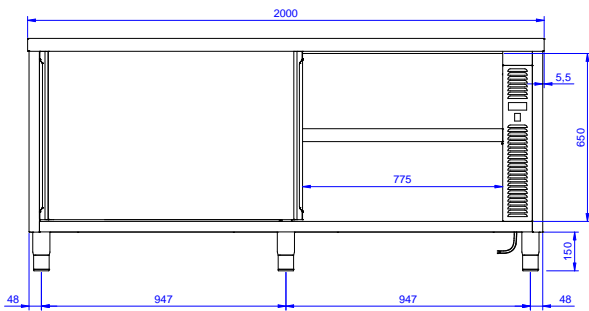

Side

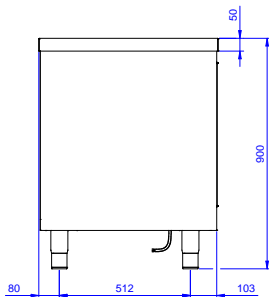

EI = Electrical inlet (power)

Top

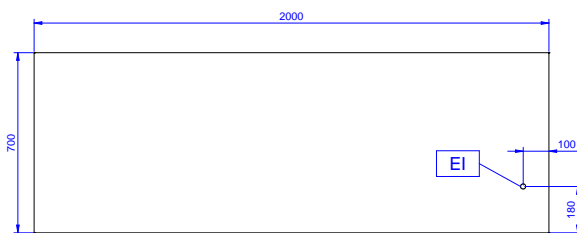

## Electric

Supply voltage:

133092 (TC2000EN)

220-240 V/1N ph/50/60 Hz

Total Watts:

2.4 kW

## Key Information:

Cabinet width:	1830 mm
Cabinet depth:	645 mm
Cabinet height:	610 mm
Cabinet temperature:	50-75 °C
External dimensions, Width:	2000 mm
External dimensions, Depth:	700 mm
External dimensions, Height:	900 mm
Number and type of doors:	2 Sliding
Worktop thickness:	50 mm
Net weight:	75 kg